

工程师电话（微信）15915717832



Level



Pressure



Flow



Temperature



Liquid  
Analysis



Registration



Systems  
Components



Services



Solutions

简明操作指南

# Minicap FTC260

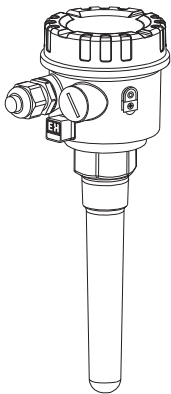

限位开关

KA00093F/28/ZH/13.14  
71287652

Endress+Hauser   
People for Process Automation

## 目录

安全指南	3
设备标识	4
安装	5
接线	7
功能	10
环境条件	14
故障排除	16
补充文档资料	17



提示



允许



禁止



目视检查

## LED 指示灯信号

绿 (gn): 工作

红 (rd): 开关状态

## 安全指南

Minicap FTC260 是限位开关，设计用于轻质散料的限位检测。

错误使用可能会导致应用危险。

仅允许**经授权的合格专业人员**进行设备的安装、电气连接、调试、操作和维护，必须严格遵守《简明操作指南》、相关标准、法规和证书 ( 取决于实际应用 ) 中的要求。

## 设备标识

测量设备的标识信息如下：

- 铭牌参数
- 订货号，标识供货清单上的设备特征

## 安装实例

X: 防护罩

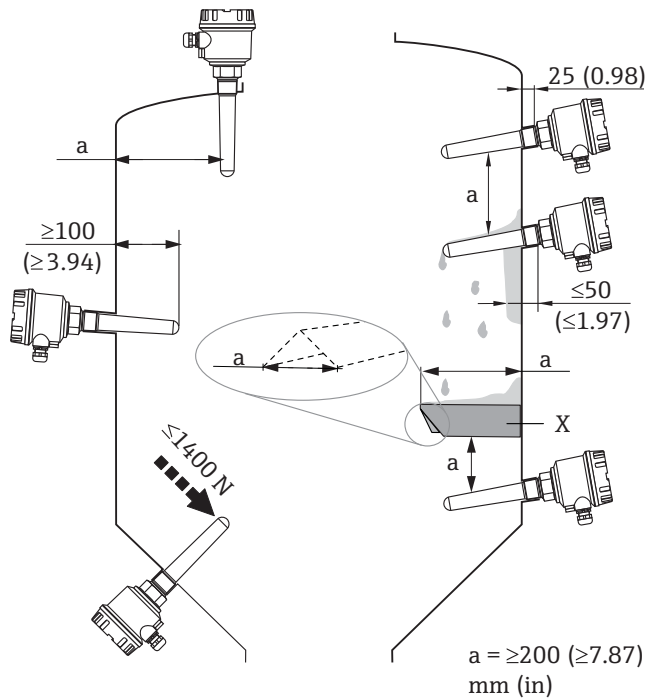

## 安装

将 Minicap 拧入至过程连接上。  
禁止通过外壳旋转拧紧。

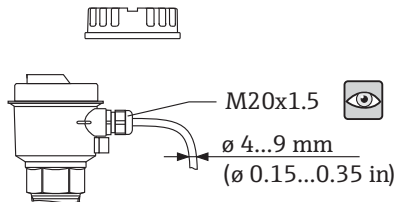
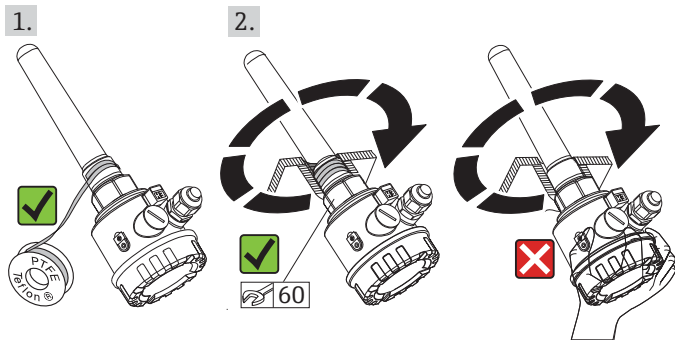

## 设置和电气连接

1. + 2. 额定电压
  3. 工厂设置
- 注意所有法规和标准!

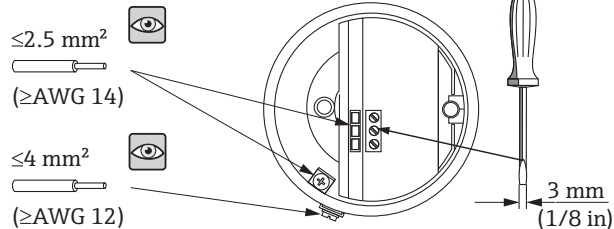
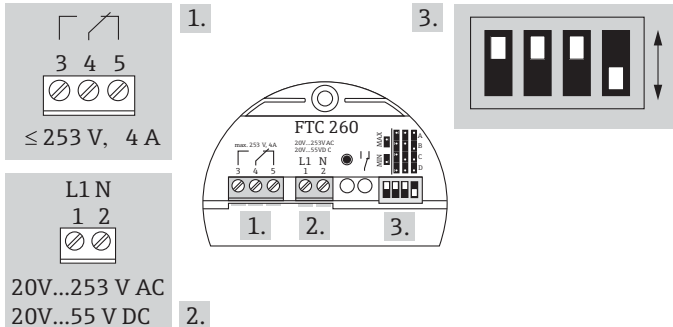

## FTC260 - ##2##

直流 (DC) 连接  
晶体管输出 PNP  
R: 外部负载

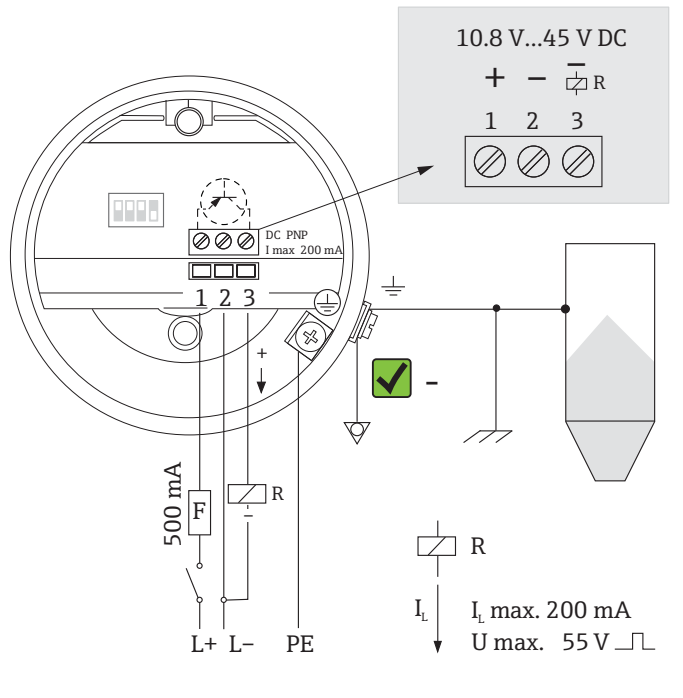



# FTC260 - ##4##

通用连接  
继电器输出

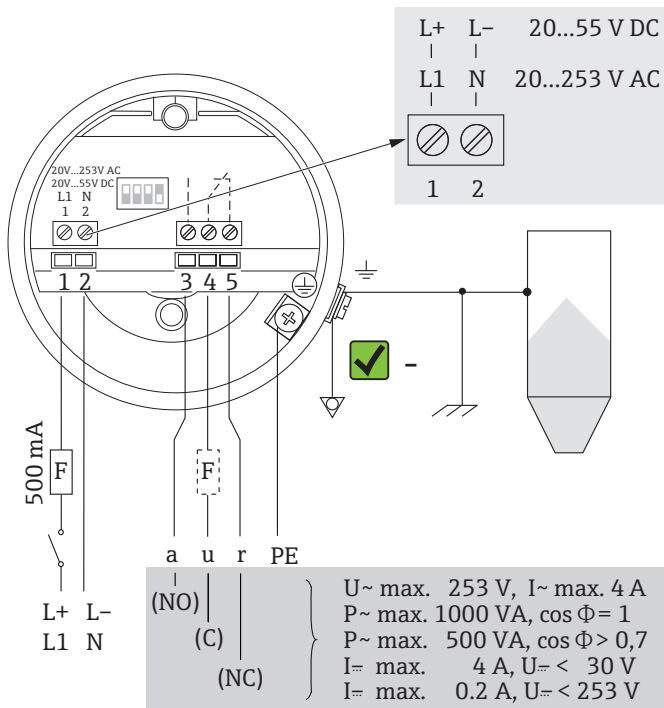

# 功能

## 设置失效安全模式

S		GN	RD	U <sub>DC</sub> DC	U <sub>AC</sub> AC/DC
				PNP	继电器
高限(MAX) 					3 4 5
					3 4 5
低限(MIN) 					3 4 5
					3 4 5
					3 4 5

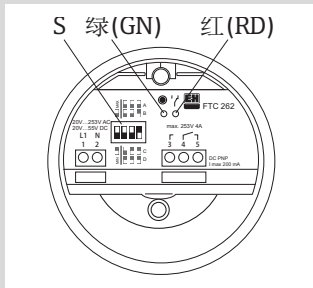

## 优化性能

仅当满足下列条件时，需要更改开关设置：

- 探头上有生成严重粘附的趋势
- 安装在非金属容器中

正确设置请参考第 12 和 13 页的表格。

优化性能设置 ( 如需要 )

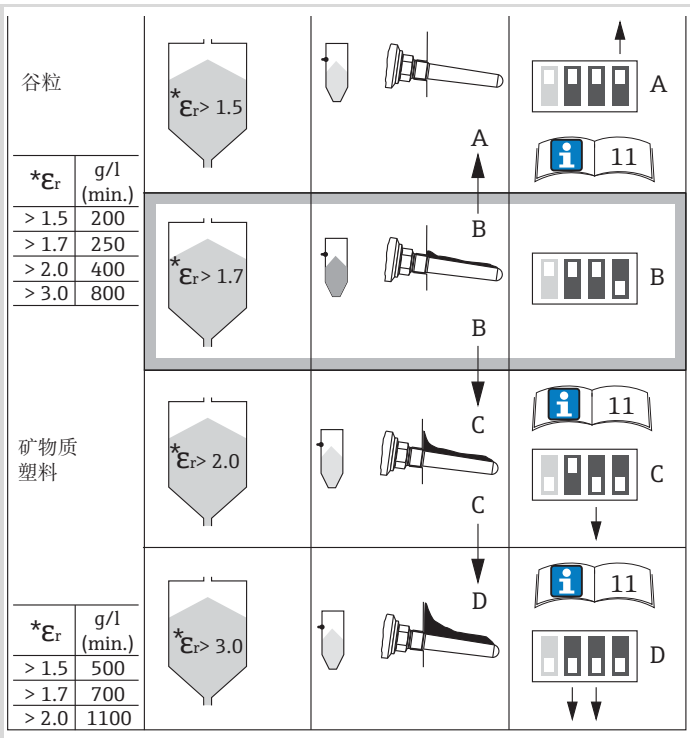

容器

M = 金属

N = 非金属

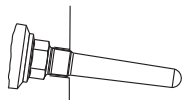
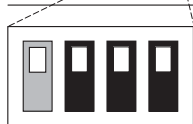
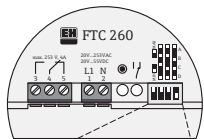

N:  $\epsilon_r > 1.6$   
M: ---

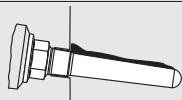

N:  $\epsilon_r > 2.0$   
M:  $\epsilon_r > 1.6$

工厂设置

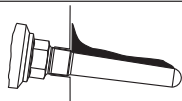
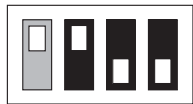

N:  $\epsilon_r > 2.5$   
M:  $\epsilon_r > 2.0$

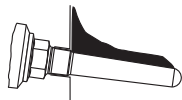
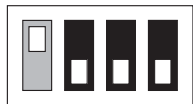

N:  $\epsilon_r > 3.5$   
M:  $\epsilon_r > 2.5$

## 环境条件

环境温度  $T_a$

工作温度  $T_p$

工作压力  $p_e$

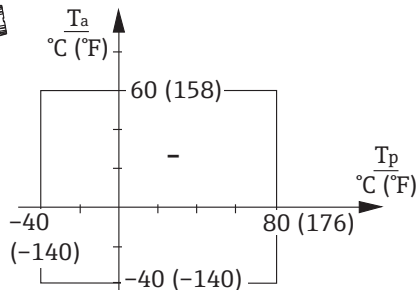
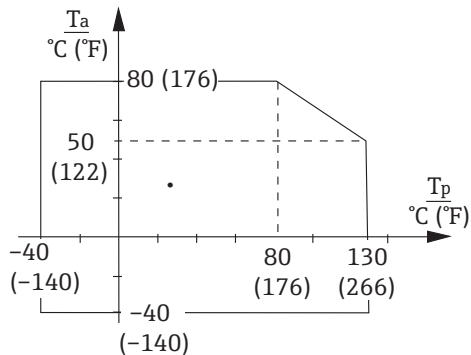
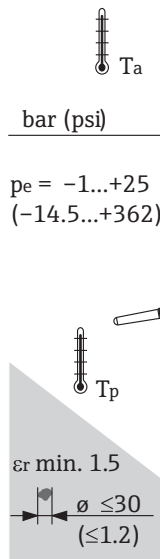

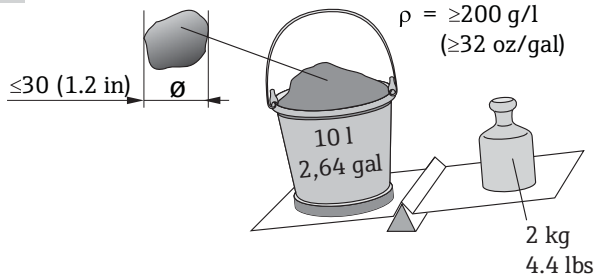
**A**

A:

固料密度  $\rho$   
颗粒大小  $\varnothing$

B:

适配接头

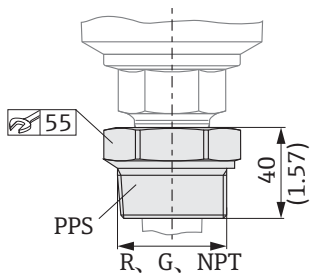
**B**

mm (in)

## 故障排除

故障	原因	补救措施
开关不动作	无电源 (绿色 LED 指示灯未亮起)	检查电源
	材料的介电常数 $\epsilon_r$ 过低	更改电子插件上的开关设置
	探头接地不良	检查料仓或金属部件的接地连接
	探头接触锥形出料口	选择另一个测量点
	探头末端有严重粘附	更改电子插件上的开关设置, 或清洗探头
	探头下拉 => 红色 LED 指示灯闪烁	更换 FTC 260 ; 选择其他安装点
	探头或外壳中的电子插件故障 => 红色 LED 指示灯闪烁	更换 FTC 260
开关不正确	交流 (AC) 型: 触点焊接在一起 (短路后)	更换 FTC 260 ; 将保险丝连接至触点回路中
间断故障切换	低限 (MIN)/ 高限 (MAX) 设置错误	在电子插件上设置正确测量模式
	直流 (DC) 型: 输出过载	减小负载、(电缆) 容抗
	探头有时处于加料区中	重新定位加料区, 或选择其他安装点
	探头接触容器壁上的粘附物	清洗容器壁上的粘附物, 或选择其他安装点
	外壳中进水	拧紧螺纹盖和缆塞



## 技术资料

Minicap FTC260、FTC262 → TI00287F

## 安全指南

Minicap FTC260 → XA00011F

## 补充文档资料





[www.endress.com/worldwide](http://www.endress.com/worldwide)

KA00093F/28/ZH/13.14  
71287652  
FM10



71287652